

8 7 6 5 4 3 2 1

D

D

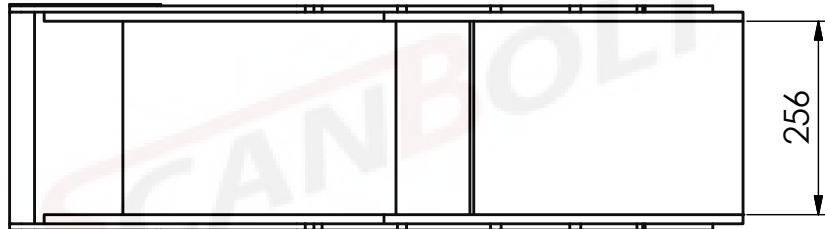
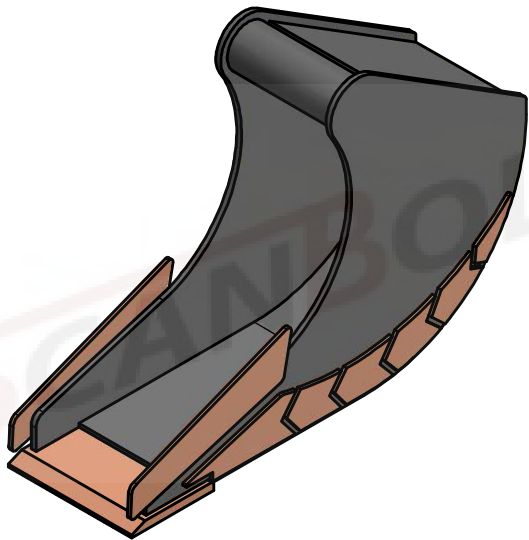

256

C

C

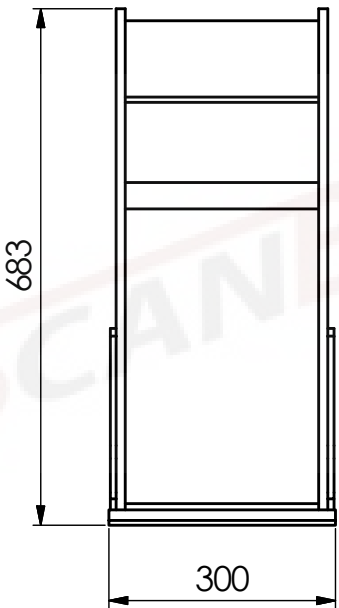

683

300

B

B

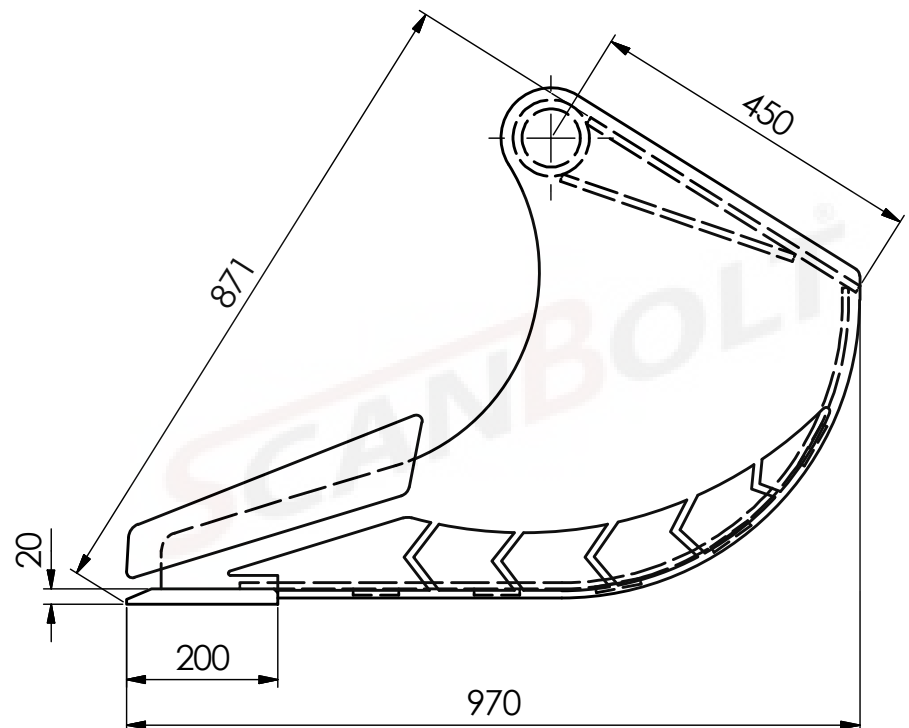

20

200





871

450

970

A

A

MATERIAL SPECIFICATION	
	ST52.3
	EN8D
	HB 400
	HB 450
	CASTALLOY STEEL

<b>SCANBOLT®</b>	
DESCRIPTION	30CM DIGGING BUCKET
MACHINE CLASS	7.5-10 TON
WEIGHT	122 Kg
HEAPED CAPACITY	96.1 LITERS

8 7 6 5 4 3 2 1